

Article number: 439600150

Description: Rota-fix shaft-hub connection FS150x200

Note: Self centering - very high torque.

Measures

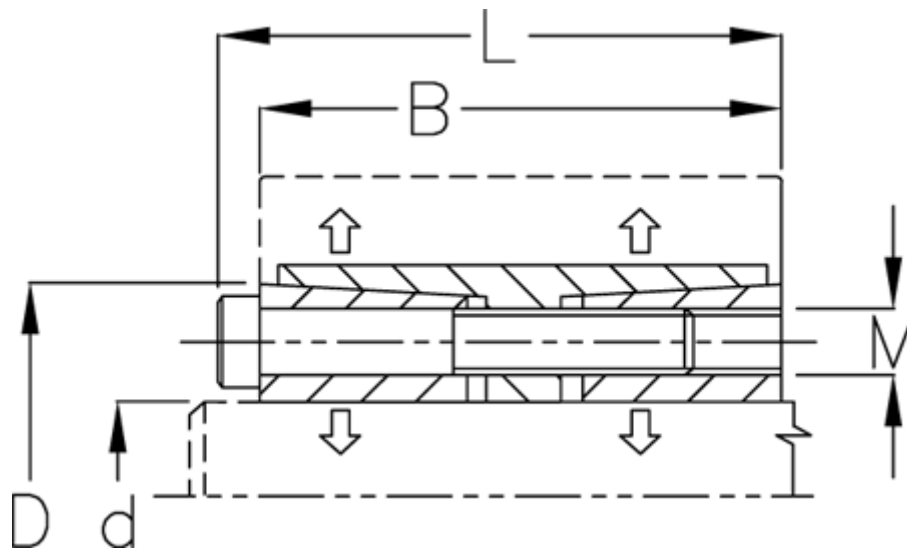

B mm	= 82
d H8 mm	= 150
D mm	= 200
Fit tolerance	= Aksel h8, Nav H8
F kN torque	= 583.0
L mm	= 94
M mm	= M12
P N/mm ² surface pressure on shaft/hub	= 144

Surface roughness	= R? ? 3.2 μm
T N m torque	= 43700
Ts N m bolt tightening torque	= 145.0